

EcoSmart 2.0 Continuous Cord Loop Installation Instructions



Read the instructions carefully before installing and using the shade(s).

Installation can be completed by non-professionals.

For Indoor Use Only

Tools required:

Measuring tape * Power Drill * Drill Bits * Phillips Driver Bit * Pencil* Level

Additional fasteners other than those sent with your shade may be required depending on the mounting surface. Wallboard and plaster require the use of anchors such as expansion or toggle bolts. Brick, tile or stone need special plugs and drill bits. Remember to always pre-drill holes in wood to avoid splitting. Contact your local hardware store for fasteners specific to your application. Please do not remove the sticker from the headrail.

It provides important information that is helpful for proof of warranty

BRACKET INSTALLATION:

NOTE: SHADES OVER 50" WIDE MAY REQUIRE 2 PEOPLE FOR INSTALLATION OF SHADE TO BRACKETS. Shades are shipped with the required number of brackets for proper installation. Brackets should be located approximately 3" from either end.

Avoid placing brackets over mechanisms inside headrail for optimal performance.

Depending on the width of the shade, additional brackets may be necessary, evenly space additional brackets between the two end brackets. Using the Installation Bracket as a template, measure 3" (or best location) in from the end of the shade and mark the hole locations with a pencil for drilling.

When mounting brackets, make sure they are in line and level. Brackets must be in line and level. The head rail must be level for the shade to operate properly.

Inside or Ceiling Mounts

Use the top bracket holes

Wall or Outside Mounts

Use the rear bracket holes

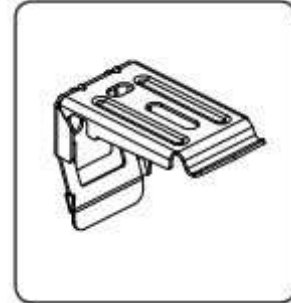
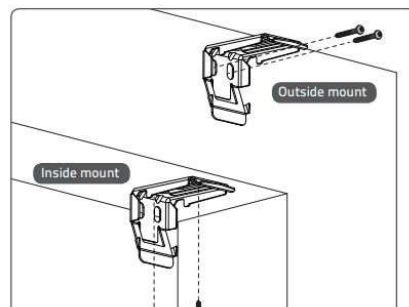

For Shade Widths	# of Brackets
Up to 35"	2
36"-65"	3
65"-95"	4
95"-119"	5

Inside Mount	2 screws/bracket
Outside Mount	2 screws/bracket

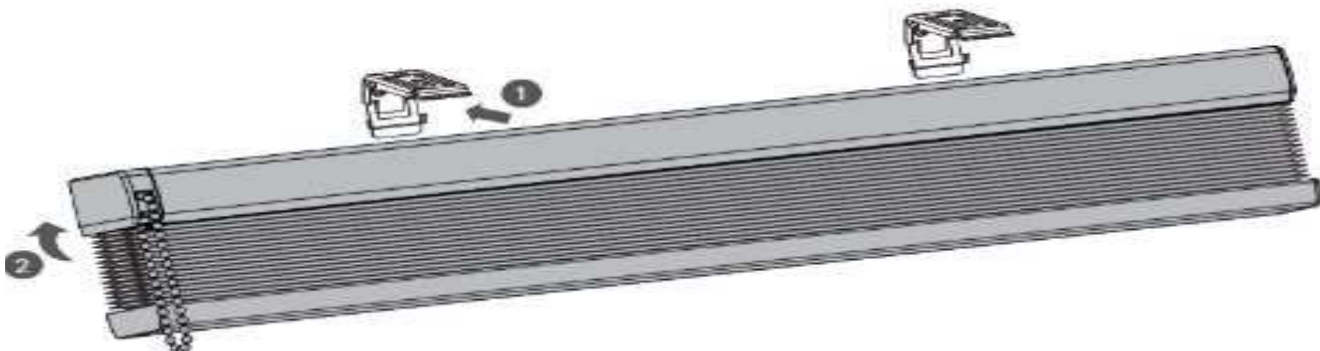

First, lower the bottom rail about an inch. This will help keep the fabric from getting caught

INSTALL THE SAFETY TENSIONER

IMPORTANT-THE CLUTCH CELLULAR SHADE WILL NOT OPERATE WITHOUT THE SAFETY TENSIONER PROPERLY INSTALLED. FOR SAFETY REASONS, THE CORDLOOP MUST BE SECURED TO ENSURE IT IS UNDER TENSION AT ALL TIMES.



1. Hook the L-bracket to the tensioner.



2. Pull down the tensioner and L-bracket together. Make sure the tiny metal bar is at the center of the groove. Mark the location of holes.

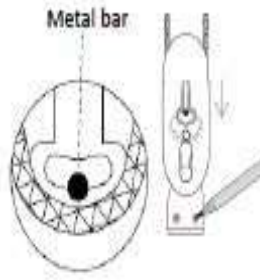

3. Mount the L-bracket with screws.



4. Secure the tensioner with the L-bracket at all the time. Both cords should have tension evenly.

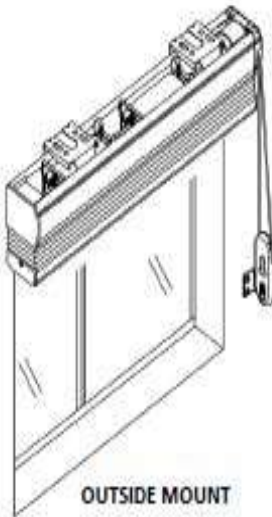
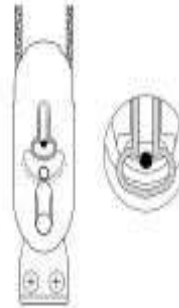

1. Hook the L-bracket to the tensioner.

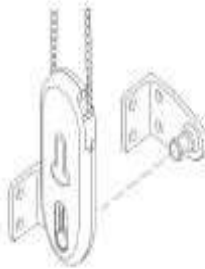

2. Pull down the tensioner and L-bracket together. Make sure the tiny metal bar is at the center of the groove. Mark the location of holes.

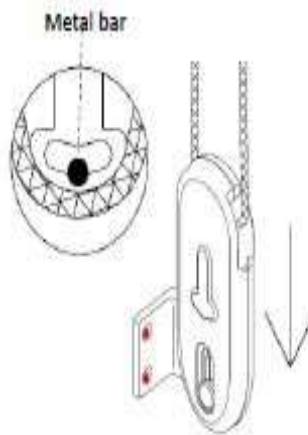

3. Mount the L-bracket with screws.

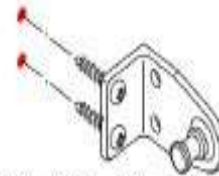

4. Secure the tensioner with the L-bracket at all the time. Both cords should have tension evenly.

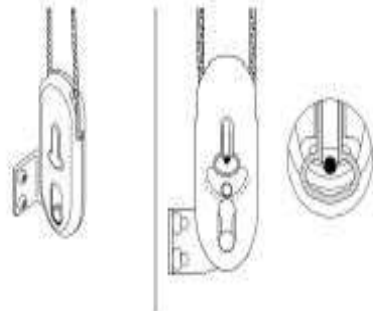

- The tensioner and L-bracket must installed properly before operating the clutch shade.
- For safety reasons, avoid having a loose cord. An incorrectly installed tensioner can lead to serious accidents. Below is an example of an incorrectly installed tensioner - the cord is loose and has no tension.



AN INCORRECTLY INSTALLED TENSIONER

Shade Operation Operate the shade by pulling down on one side of the cord. – The front cord raises the shade; the rear cord lowers the shade. Do not lift the bottom rail with your hands. Also, be careful not to place objects on the window sill that will interfere with operating the shade or cause it to hang unevenly.

Bottom Up:

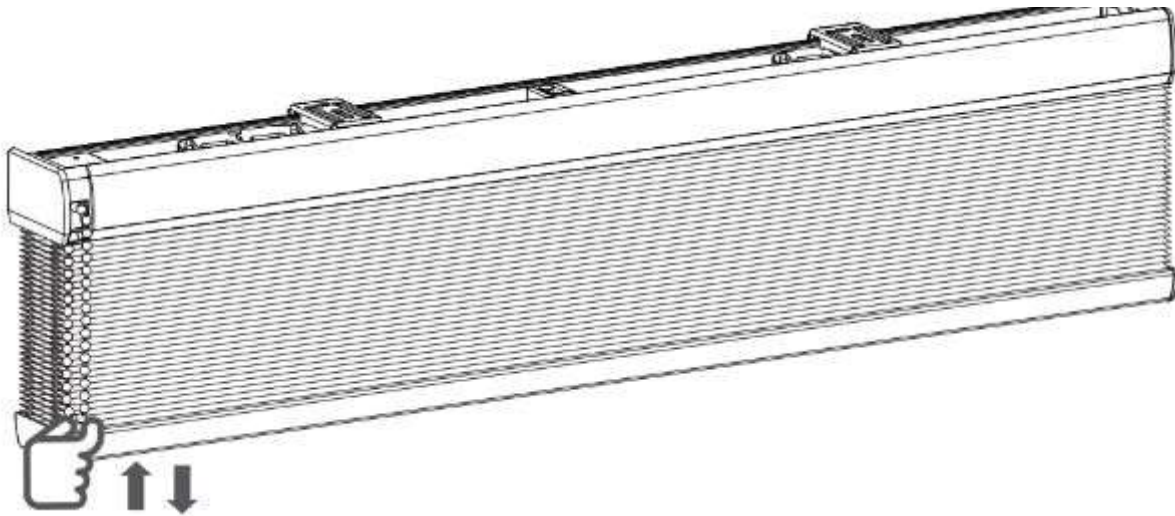

Top Down/Bottom Up:

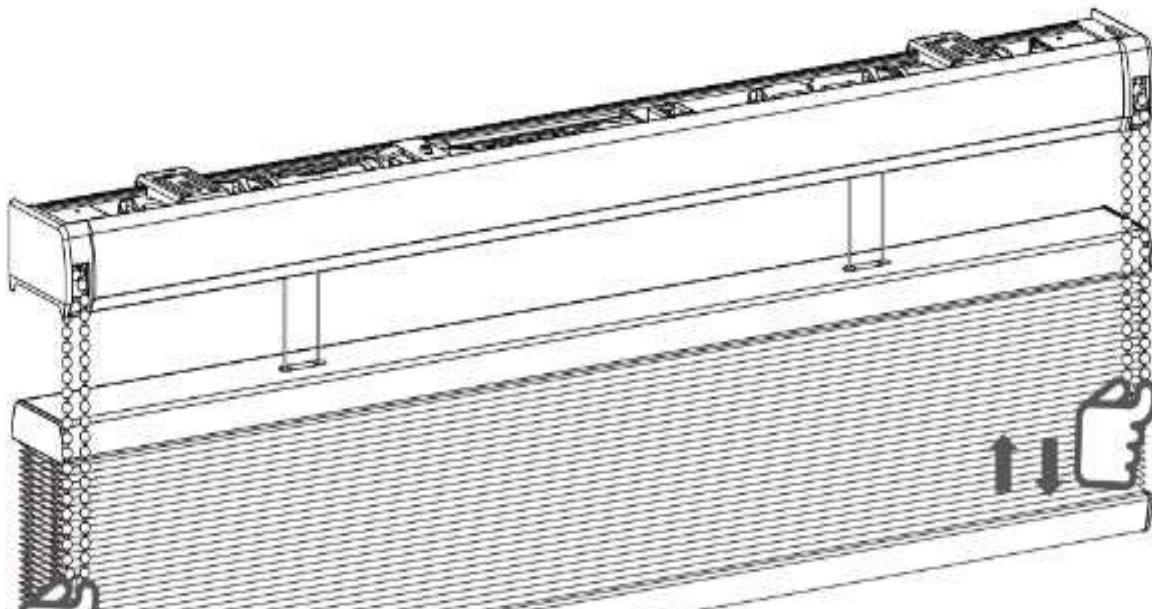

Removing the Shade from the Headrail

To remove a shade, insert a screwdriver between the headrail and the bottom back of the bracket.

Gently pry the screwdriver to release the bracket from the headrail. Take care not to damage the painted finish of the headrail and the fabric.

As you release the brackets, hold the headrail to keep it from falling.

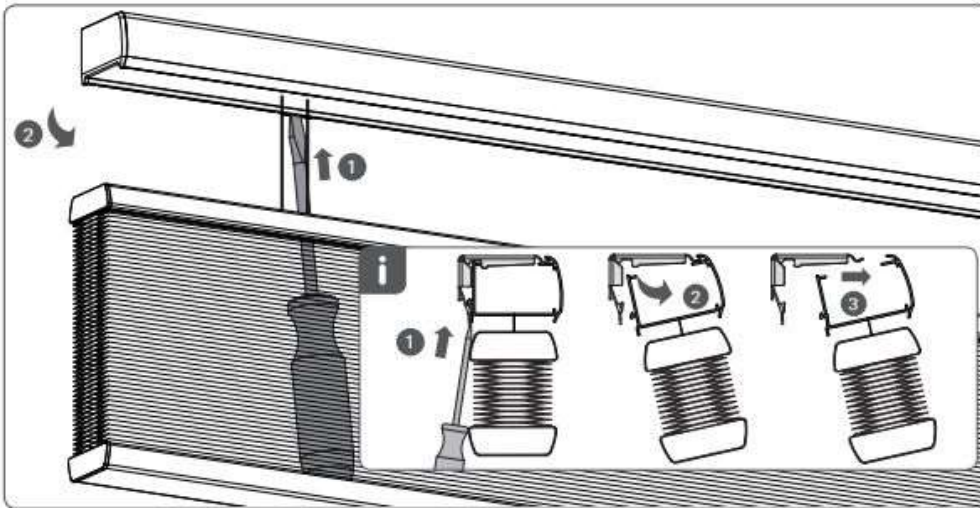

WARNING

- Young children can strangle in the loop of pull cords, chains and tapes, and cords that operate window coverings.
- To avoid strangulation and entanglement, keep cords out of the reach of young children. Cords may become wrapped around a child's neck.
- Move beds, cots and furniture away from window covering cords.
- Do not tie cords together. Make sure cords do not twist together and form a loop.

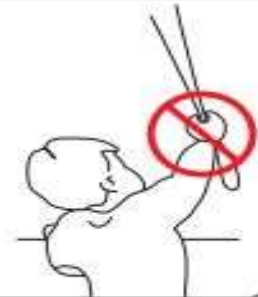

Trouble Shooting

Problem: The shade will not stay down.

Cause: Because the shade was fabricated primarily in the closed position, the fabric may want to spring up.

Repair: For a light filtering shade, with clean hands, gently pull down on a section of cells to relax the pleats. Repeat with another section of cells until the fabric is sufficiently relaxed. For a room darkening shade, avoid wrinkling the front of the fabric by grabbing shade at the sides and stretching downward. Do not fully raise the shade for 24 hours.

Cleaning & Care

IMPORTANT: Do not immerse headrail or blackout fabric in water.

- To clean surface-level dust and dirt, lift it away by gently sweeping it across the fabric with a duster or vacuum it gently with the soft brush attachment.
- If any debris is trapped inside the fabric cells, blow it out with compressed air or with a hairdryer on a slow speed and cold mode.